



Club Race Officer Webinar 2021 - 2024



Welcome

Australian
Sailing 

HOUSEKEEPING



**Please mute
microphone when
not talking**

**Webcam off helps
those with slower
internet
connections**

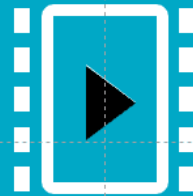

**You'll get the
slides via email**

**A recording of the
webinar will be
emailed to you
within 24hours**



**Questions can be
submitted via the
chat/conversation
feature and will be
answered during
the webinar**

Microsoft Teams Help

Mute Mic

Raise Hand

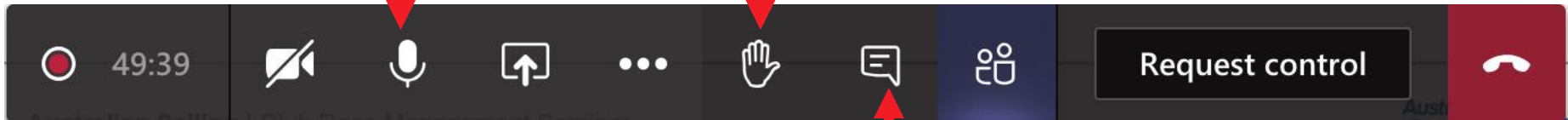

Ask a question

INTRODUCTION

- Presenters
- Participants
- How to become a Club Race Officer
- Objectives of the Webinar
- Reference Material

CLUB RACE OFFICER

CLUB RACE OFFICER CRITERIA

- Current member of their club
- Agree to the “Code of Conduct for Officials”
- Attended an Australian Sailing race officer webinar in the past 4 years

AUSTRALIAN SAILING OFFICIALS' CODE OF CONDUCT

- Maintain a high level of understanding and application of the rules, procedures and Australian Sailing policies;
- Ensure that each decision or action taken is based upon the rules and principles of fairness and objectivity, and is made with care and without prejudice;
- Uphold the confidentiality of committee and jury deliberations during and after the regatta;
- Be polite, courteous, open-minded, and patient with colleagues, competitors, regatta officials, team officials, coaches and hosts, and to respect cultural differences;
- Declare, without delay, any apparent conflict of interest which may arise;

AUSTRALIAN SAILING OFFICIALS' CODE OF CONDUCT

- Arrive at the event in adequate time and remain until after all duties are completed;
- Incur only expenses that are necessary, and when expenses are reimbursed, to claim only legitimate and essential out-of-pocket costs;
- Maintain high standards of behaviour and good manners, including being on time, wearing appropriate clothing, refraining from inappropriate smoking, and maintaining only a moderate consumption of alcohol (total avoidance before important decision making)
- Agree to the Australian Sailing Membership Protection Policy

RESOURCES & EQUIPMENT

Session 1

RACE MANAGEMENT RESOURCES

What people resources are need to conduct a race?

- Race Start Team
- Course Boat Team
- Safety Boat Team
- Race Finish Team
- Results Team

RACE OFFICER

Person in charge of the Race Management Team:

- Check your club's Duty List
- Brief the Club Volunteers on the day's activities

GUIDE TO START BOAT EQUIPMENT

- All weather clothing
- Buoyancy aid
- Wind direction indicator
- Hand bearing compass
- Anemometer
- Tape recorder
- Radio
- Timer
- Course laying aids



GUIDE TO START BOAT EQUIPMENT

- GPS
- Mobile phone
- Binoculars
- Whistle
- Loud Sounding Horn
- All Race Documentation
- Signal Flags
- Sunscreen
- Range Finder



SAFETY AND WEATHER CHECKS

Session 2

SAFETY

Safety Operations Plan

- Minimum Safety Requirements
- Rescue Boats and Personnel
- Rescue Patrol Plan
- Emergency Response Plan
- Communication Plan
- First Aid Facilities
- Risk of Entrapment by a Trapeze Harness Hook

WIND STRENGTH

How to find wind strength:

- Anemometers
- Lower wind strength
- Upper wind strength
- Follow the published wind range guidelines
- BoM forecasts and various apps

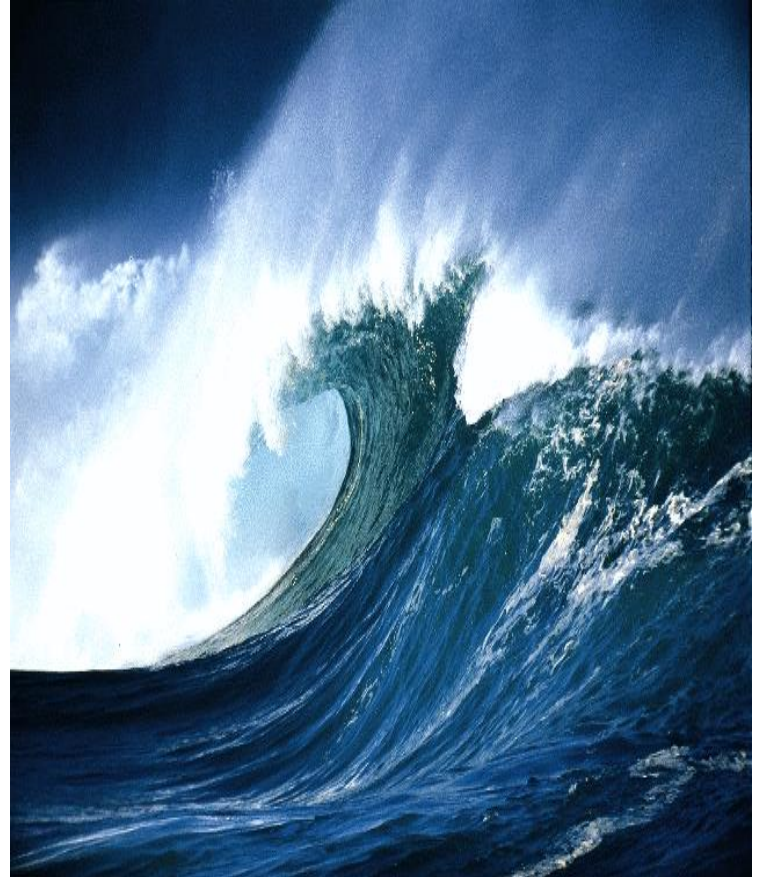

WIND DIRECTION

How to find the average wind direction:

- Wind indicators
- A wind vector
- The average wind

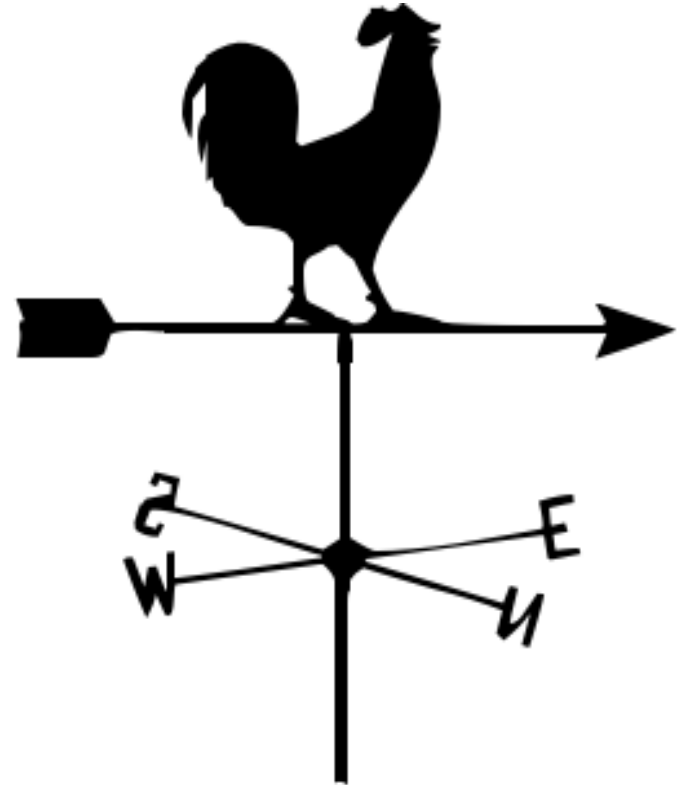

SETTING UP FOR THE COURSE AND THE START

Session 3

COURSES

- Windward – Leeward Course
- Trapezoid Course
- Triangle Type Course
- Gates
- Off-set marks
- Fixed Marks

CONSIDERATIONS WHEN SELECTING A SUITABLE COURSE

What is used at your club?

- Consistency
- Not complicated
- Port roundings
- Class requirements
- Water available to sail in
- Wind strengths

WINDWARD-LEEWARD

Windward-Leeward

Alternatives for this course are:

- No gate at Mark 2
- More rounds
- Finish upwind of Mark 1

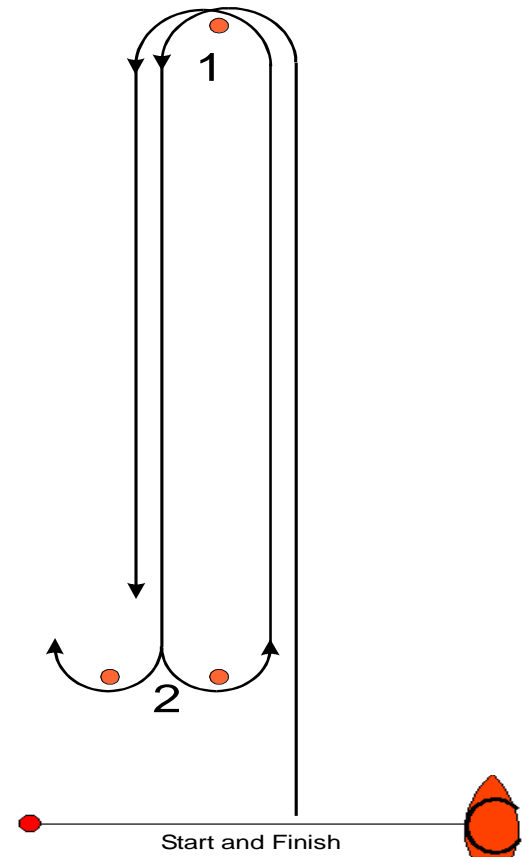

WINDWARD-LEEWARD

Alternatives for this course are:

- Reaching finish off Mark 2
- Use when only one committee vessel is available for both start and finish

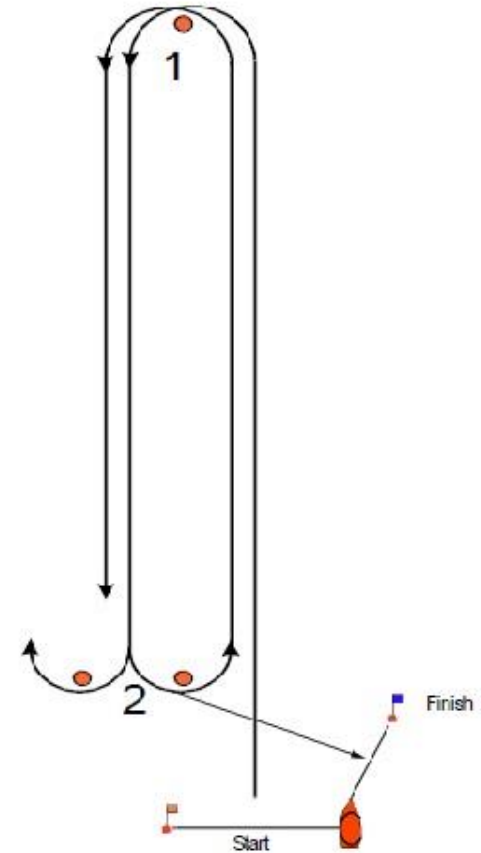

TRAPEZOID COURSE

- Two parallel windward-leeward courses

- Use with two classes

or

One class using flights

Trapezoid
Inner & Outer Loops

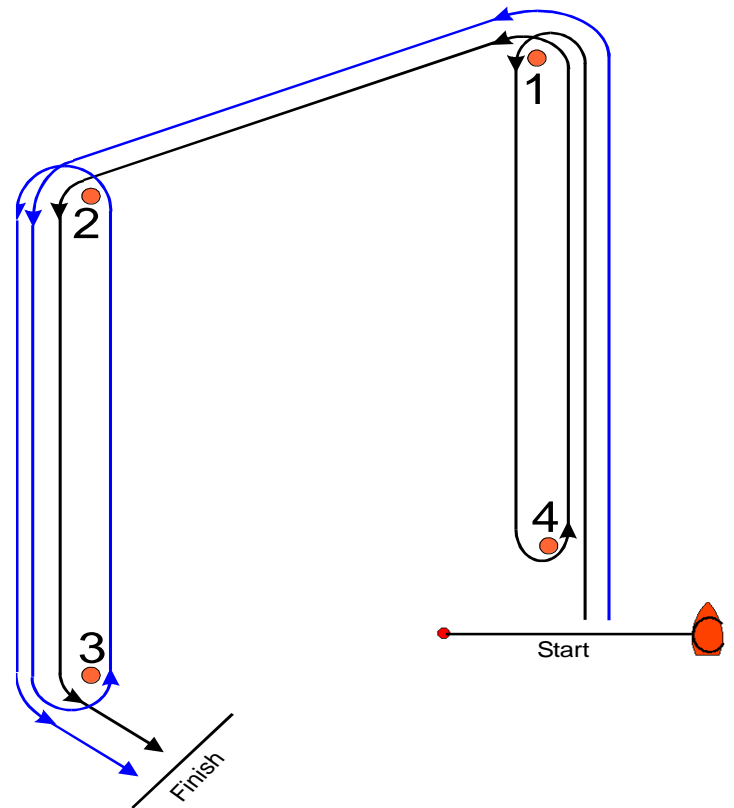

TRIANGULAR COURSE

Windward-Leeward-Triangle

Course angles can be:

- 60°
- 45° (90° at mark 2)
- 70° (to give a close reaching leg and a broad reaching leg)

The finish can also be located downwind of Mark 3

These days, some classes prefer the Windward/Leeward before the triangle

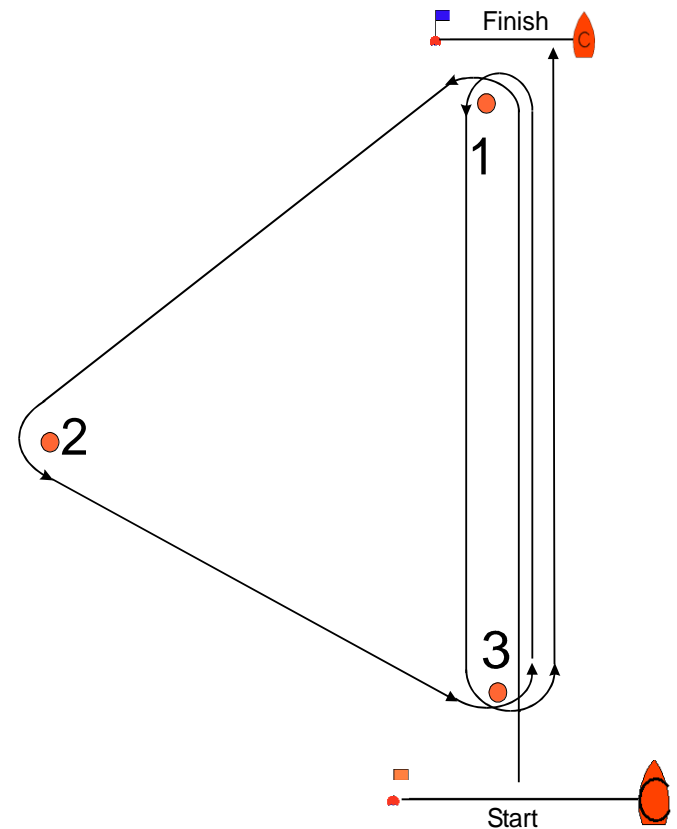

TRIANGULAR COURSE

Option for a reaching finish off Mark 3

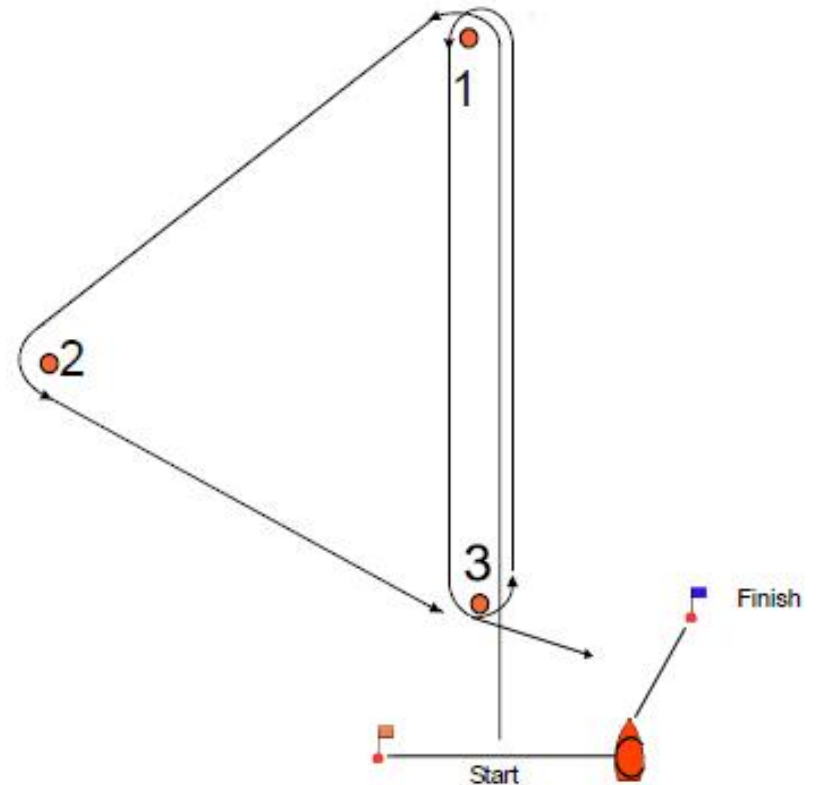

FIXED MARK COURSES

- Ideally an upwind first leg
 - Makes setting up the start line easier (square to the wind)
 - Can be created by laying a windward mark (0.05 – 1.0 nm) upwind of the start
 - If the first leg is not upwind consider what bias may be appropriate on the start line to spread the fleet out along the line
- Not all reaching legs – ideally some upwind and downwind legs
 - Can depend on the types of boats and the event
- Require sufficient depth for all boats in the fleet at all marks (including the start/finish area)

Some clubs run fixed mark courses with tower starts and an occasional on water start where the first mark after the start is replaced by a mark upwind of the start line.

THE OFFSET MARK

- Distance and angle depend on the requirements of the class
- Designed to keep boats commencing run with spinnakers separate from boats approaching Mark 1 on a beat

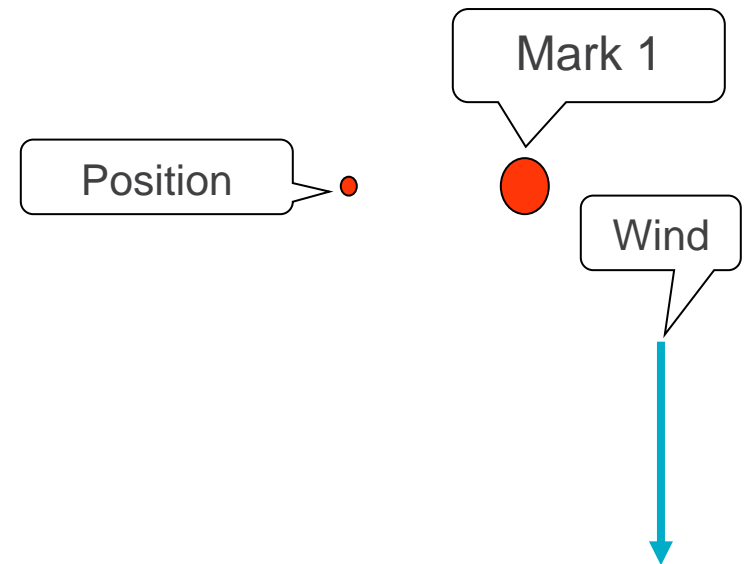

THE GATE

Most windward-leeward courses have a gate as the leeward mark

- The gate requires three boat length circles around each mark, with a space between the circles
- Therefore, minimum width of a gate is 7 boat lengths
- Most gates are set between 8 and 10 boat lengths
- Greater distance is required in stronger winds and for the new high performance boats

Direction from last mark



Gate Mark



Gate Mark

THE STARTING LINE - LENGTH

The formula is:

- Number of boats x length of the boat, plus 10% to 200%

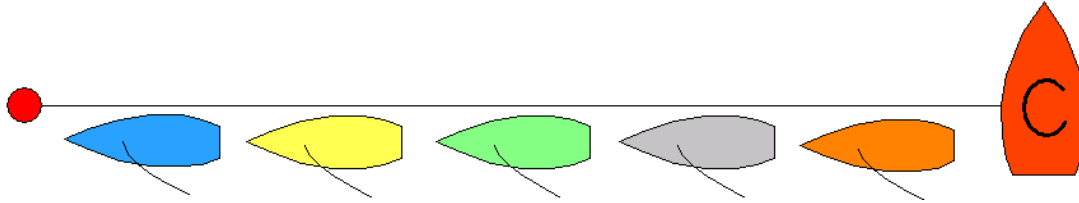

Other factors are:

- Size and manoeuvrability of boats
- Sea conditions
- Wind strength
- Current

LAYING THE START LINE

- Position the boat so that the course can be adjusted to a new wind without moving the Race Committee Boat
- Use a long anchor line so that the start line can be ‘fine tuned’ by pulling in or letting out the anchor line
- Position the pin end at 90° to the mean wind

STARTING FLAGS AND PROCEDURES

Session 4

STARTING

The standard starting system is described in the Rules (RRS26)

- This should be used whenever possible
- The time between the warning signal and the preparatory signal can be varied by the Sailing Instructions without changing RRS 26
- When racing 'back-to-back', a Sailing Instruction is required to warn sailors of an impending starting sequence (refer Appendix LG 6.4)
- Decision to Race
- Starting penalties are incorporated into the preparatory signal

VOICE RECORDER

From approximately 90 seconds before the start signal, record all you see on your voice recorder

- Describe the scene as if you were a commentator making a radio broadcast
- Wind conditions
- Sea state
- Boat numbers
- The position of boats on the line
- Your ability to see the pin end
- Any other relevant information that will be of assistance in a redress hearing



470



Nolex

SIGHTING THE LINE

- Stand behind the mast at least 1 metre away. Don't fall overboard!
- Sight on the pin-end
- Don't forget that both ends of the line are moving
- **Record everything on your voice recorder**

FLAGS AT THE START

Flags required on the Start Boat

- Preparatory Flags: P, I, Z, U and Black
- Recall Flags: 1st Sub, X
- Postponement Flag
- Abandonment Flag
- A & H Flag
- Start Line Flag (Orange)
- Warning Signal Flags
- RRS 25.3 or an object of similar appearance

LAYOUT OF FLAGS & HALYARDS

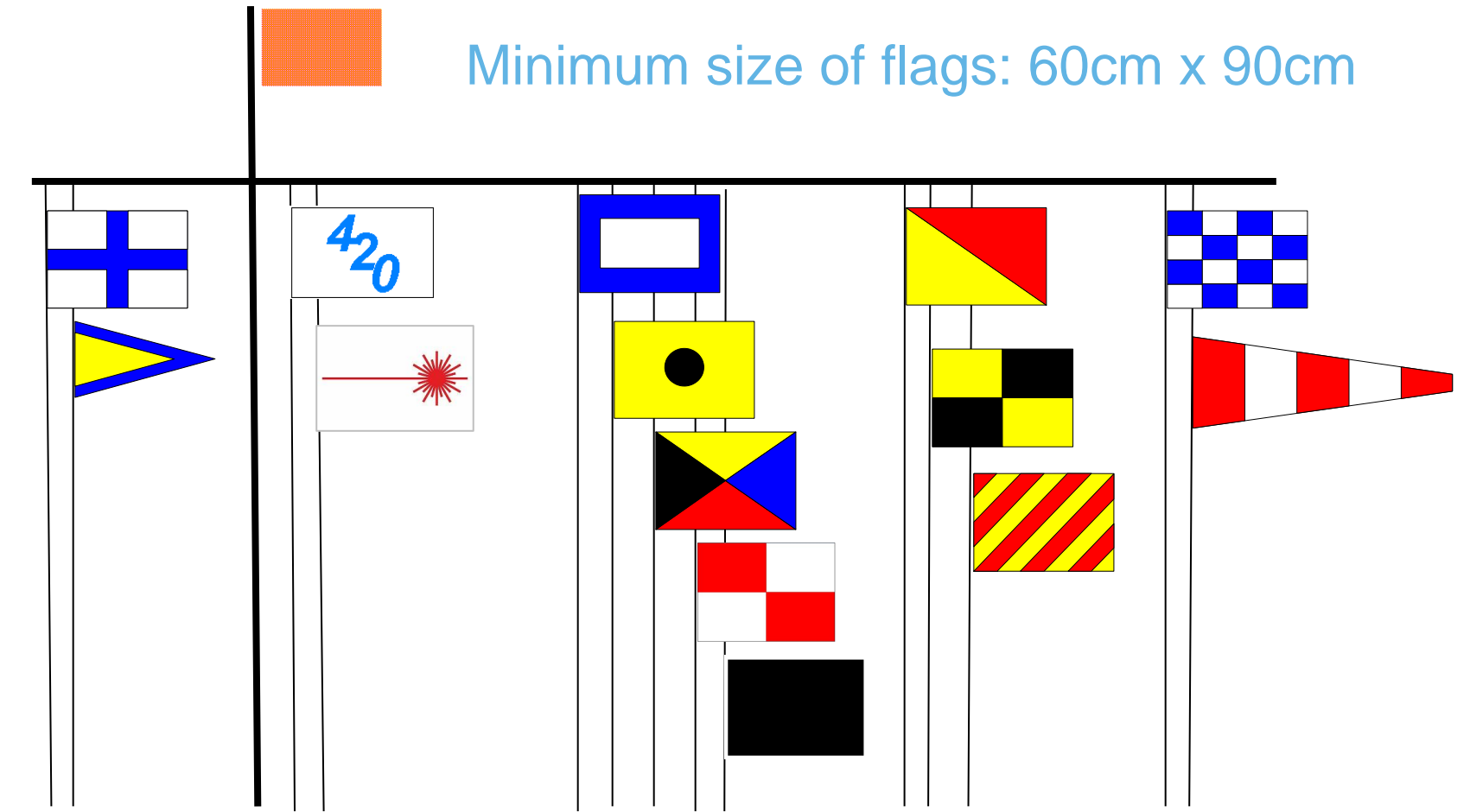

THE WARNING SIGNAL

The first signal in the starting sequence

- This should be displayed precisely at the time stated in the Sailing Instructions
- Sailors will start their stopwatches on this signal
- To assist sailors, many class flags bear the sail insignia of the class about to start
- Accompanied by one sound signal

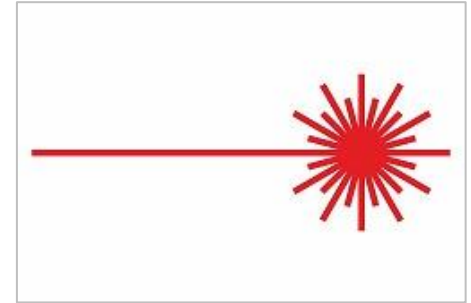

THE PREPARATORY SIGNALS

There are five preparatory signals

- 'P' no penalties
- 'I' penalty (RRS 30.1)
- 'Z' 20% Scoring (RRS 30.2)
- 'U' (RRS 30.3)
- 'Black' (RRS 30.4)

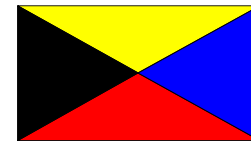
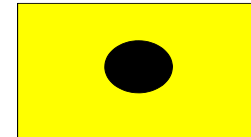

“I” FLAG RULE

Flag ‘I’ and 1 sound signal (RRS 30.1)

- Can cause the fleet to bunch at each end
- May create a large gap in the middle of the line

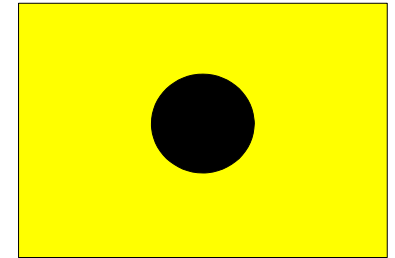

20% PENALTY RULE

Flag 'Z' and 1 sound signal(RRS 30.2)

- The penalty area is the triangle formed by the start line and Mark 1
- A boat which enters the penalty area in the minute before her start can dip back over the start line to the pre-start side
- Each time she infringes the penalty area after a General Recall or an Abandon signal, she is subject to an additional 20% penalty

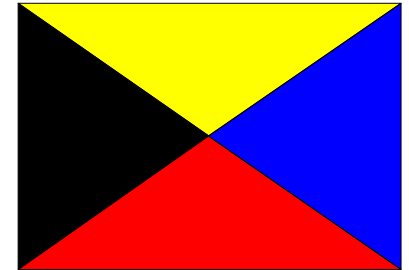

“U” FLAG RULE

The ‘U’ Flag and 1 sound signal (RRS 30.3)

- This penalty should be used when the fleet are causing the problems
- This rule can be used prior to resorting to the Black Flag (RRS 30.4)
- At the top level of sailing or in championship regattas, this flag may be used on the first start instead of flag “P”
- A Race Officer should always use this flag with care

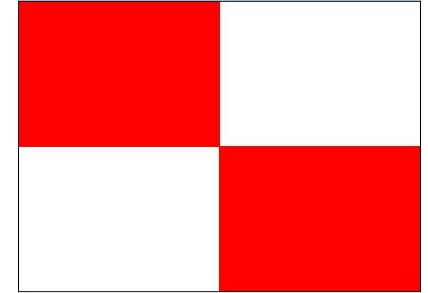

BLACK FLAG RULE

The 'Black' flag and 1 sound signal (RRS 30.4)

- This penalty should be used when it is the fleet causing the problems and not as a result of the setting of the start line
- At the top level of sailing, after a general recall on the first attempt with a U flag, the RO will generally go to Black if it is the competitors causing the problem
- An important principal is that the Black Flag is only used when general recalls are being caused by the competitors and not by the actions of the Race Management team
- The Race Management team should have a clear understanding of how the process should be managed and their obligations for advising the fleet of any boats being penalised under this rule
- A Race Officer will use this flag with care

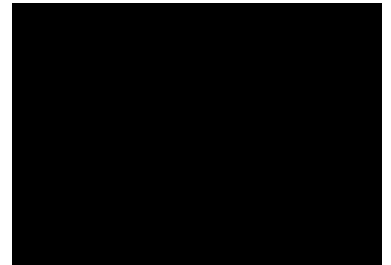

REMOVAL OF THE PREPARATORY SIGNAL

This is done precisely one minute before the start signal

- A long sound signal is made at this time
- If a penalty signal has been used as a preparatory signal, this is the time when the penalty period commences

INDIVIDUAL RECALL

Flag X and 1 sound signal (RRS 29.1)

- This signal must be displayed within 5 seconds of the start signal
- It must be accompanied simultaneously with a sound signal
- It remains on display until all OCS boats have returned and started, or for 4 minutes, or until 1 minute before the next starting signal
- It is removed without a sound signal
- Make every effort to identify all OCS boats
- Refer to Case Book - Case 79

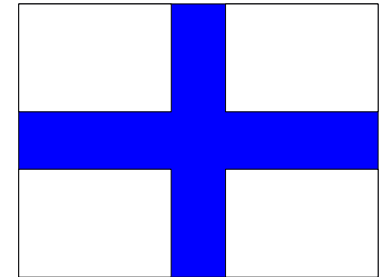

GENERAL RECALL

Flag 1st Sub – 2 sound signals (RRS 29.2)

- Should be used reluctantly
- A good start line will reduce the need for this signal
- A short start line with fewer boats will make this signal almost redundant
- Take care when penalty signals are used as the Prep Signal, especially the Black Flag
- Removed with 1 sound signal 1 minute before the next signal

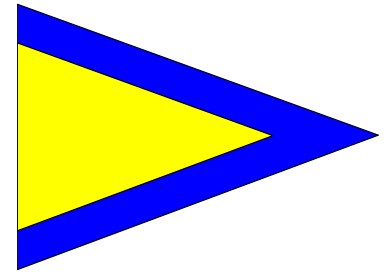

POSTPONEMENT

There are four Postponement signals

- Indefinite Postponement
- Postponement of scheduled starting time
- Races Postponed – further signals ashore
- Races Postponed –no more racing today

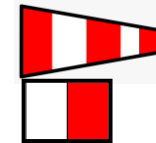
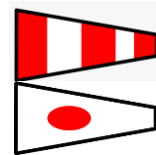

RACE CONTROL

Session 5

AFTER THE START RACE CONTROL

Once the race has started, the Race Officer has a number of duties:

Monitoring the weather conditions:

- Is the wind speed dropping?
- Is it still safe to race?
- Are the time limits being met?
- Has the wind moved left or right?
- Are all the marks still in place?

Recording:

- At the end of each round (or mark)

ABANDONING A RACE

Flag 'N' with 3 sound signals (RRS 32.1)

- This signal can only be used after the start
- There are two other Abandon signals. Each require 3 sound signals

Both can be used at any time:

- 'N over H'
- 'N over A'

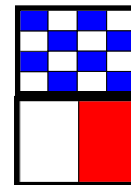
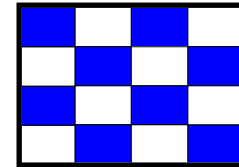

ABANDONING AFTER THE START

RRS 32.1

After the starting signal, the Race Committee may abandon the race (display Flag N, N over H, or N over A, with three sounds):

- Because of foul weather
- Because of insufficient wind making it unlikely that any boat will finish within the time limit
- Because a mark is missing or out of position, or
- For any other reason directly affecting the safety or fairness of the competition

(Additionally you may abandon a race because of an error in the starting procedure)

However...

After one boat has sailed the course and finished within the time limit, if any, the Race Committee shall not abandon the race ***without considering the consequences for all boats in the race or series.***

SAFETY

Search and Rescue Instructions (RRS 37)

- Flag V displayed with 1 sound signal
- All boats and official and support vessels shall, if possible, monitor the race committee communications channel for search and rescue instructions.

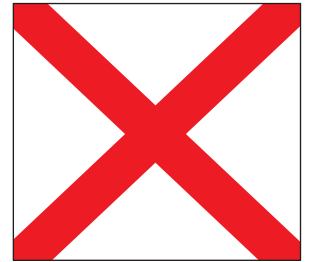

CHANGING THE BEARING OF THE NEXT LEG OF THE COURSE

RRS 33

Change of bearing of the next mark:

- Flag 'C' or an object of similar appearance with a repetitive sound signal

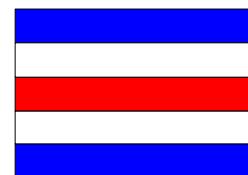

This must be displayed with one or both of:

- A new bearing for the next mark and/or;
- A red rectangle when the new position is to port of the original, or:
- A green triangle when the new position is to starboard of the original

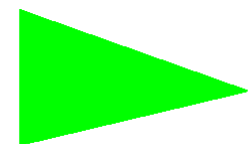

CHANGING THE LENGTH OF THE NEXT LEG OF THE COURSE

RRS 33

Increase or decrease in wind strength Flag 'C' or an object of similar appearance with a repetitive sound signal

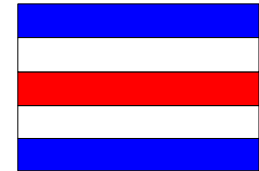

This must be displayed with either:

- A plus sign if the leg is to be significantly increased in length
- A minus sign if the leg is to be significantly reduced in length

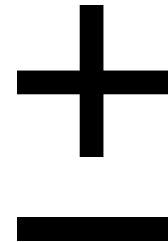

CHANGE OF COURSE AT A GATE

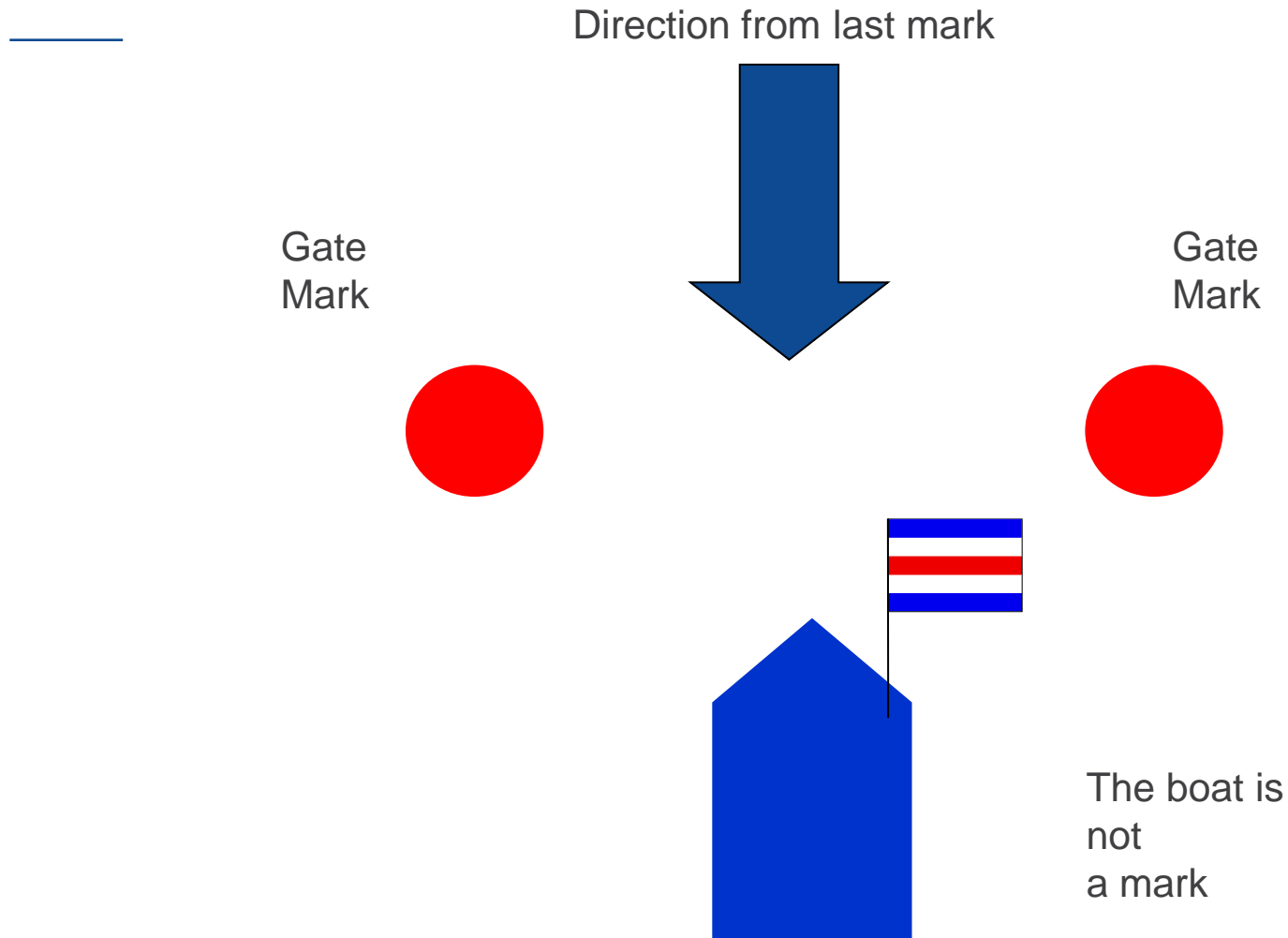

MARK CHANGE SIGNAL BOAT POSITION

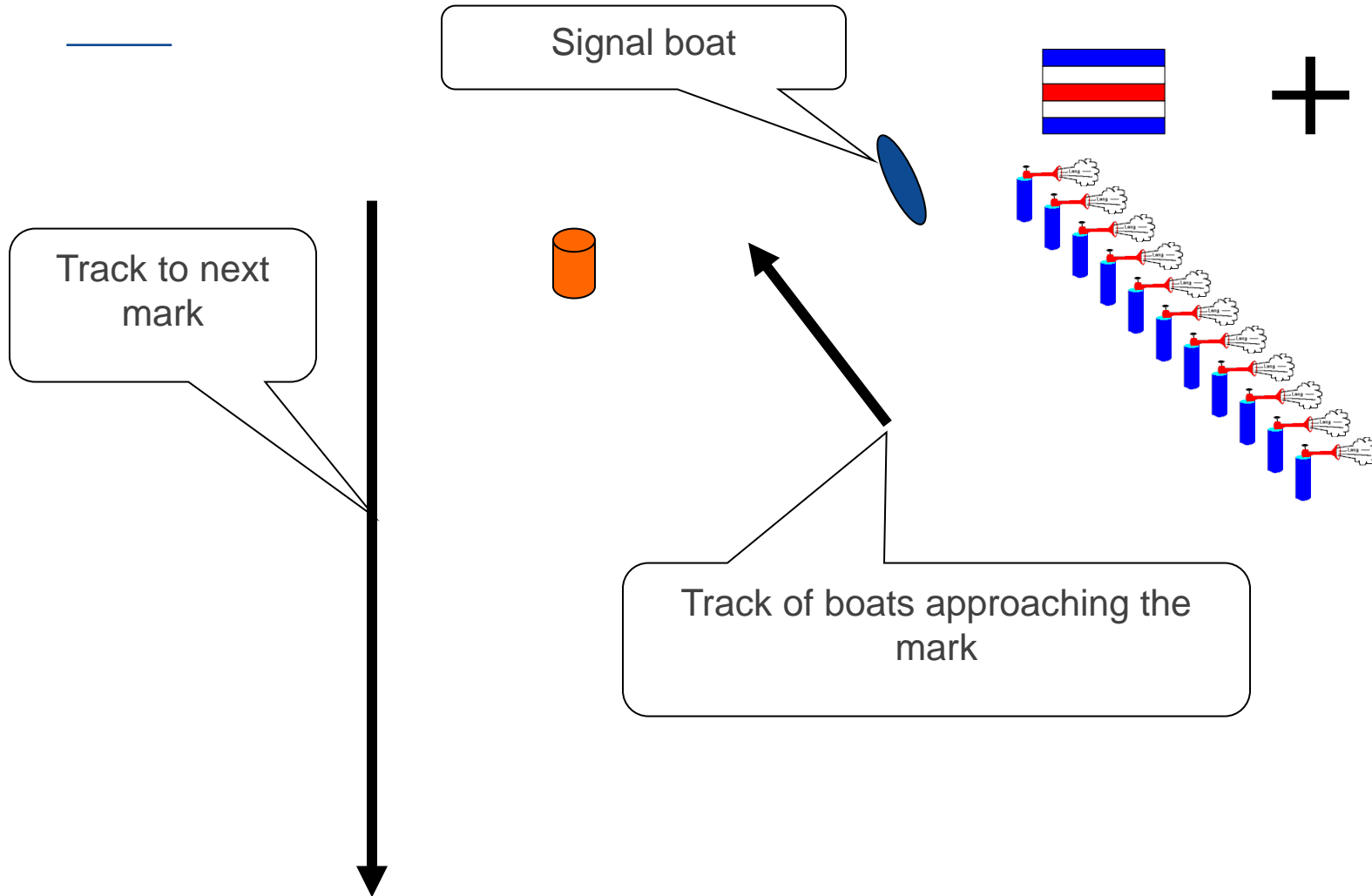

SHORTENING AFTER THE START

(RRS 32)

After the starting signal, the Race Committee may shorten the course (display Flag S with two sounds). Refer RRS 32.1 and 32.2.

- When is this signal made?
- How often is the sound made?
- Can you do this if it is not in the Sailing Instructions?
- Where is this signal flown?
- Where is the Finish Line?

SHORTEN COURSE

Flag 'S' – two sound signals (RRS 32.1 and 32.2)

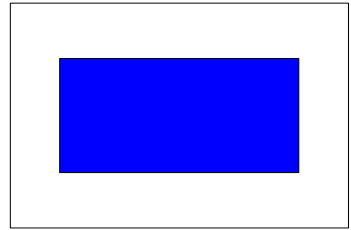

- One or more legs cut off the course that was displayed at the warning signal
- Because of foul weather
- Because of insufficient wind making it unlikely that any boat will finish within the time limit
- So that other scheduled race/s can be sailed
- Signal made from the CV at the shortened course finish line as boats commence leg towards new shortened course finishing line
- Signal displayed on committee boat is further away from fleet than any other time a signal is displayed

Some events do not allow shorten course

SHORTENING AT MARK - PORT ROUNDING

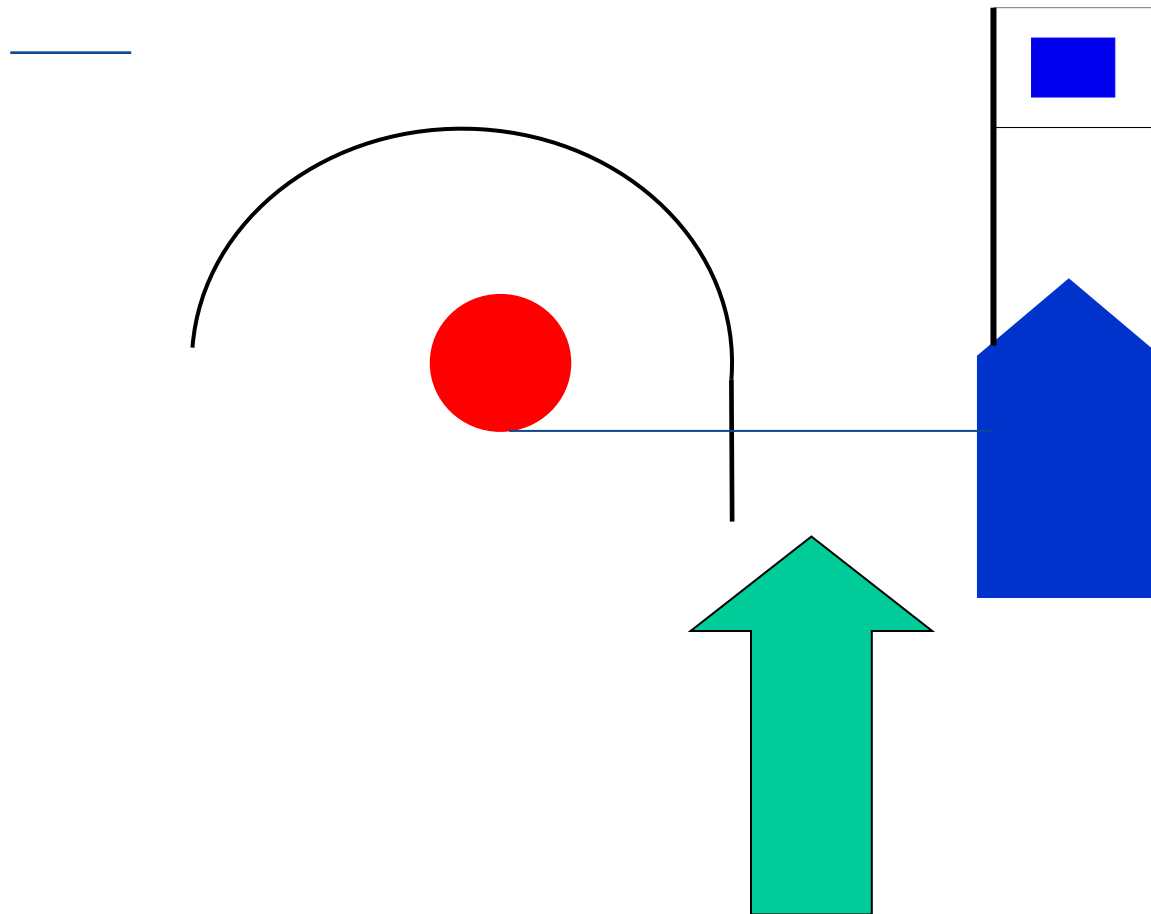

Direction from last mark

SHORTENING AT A GATE

Direction from last mark

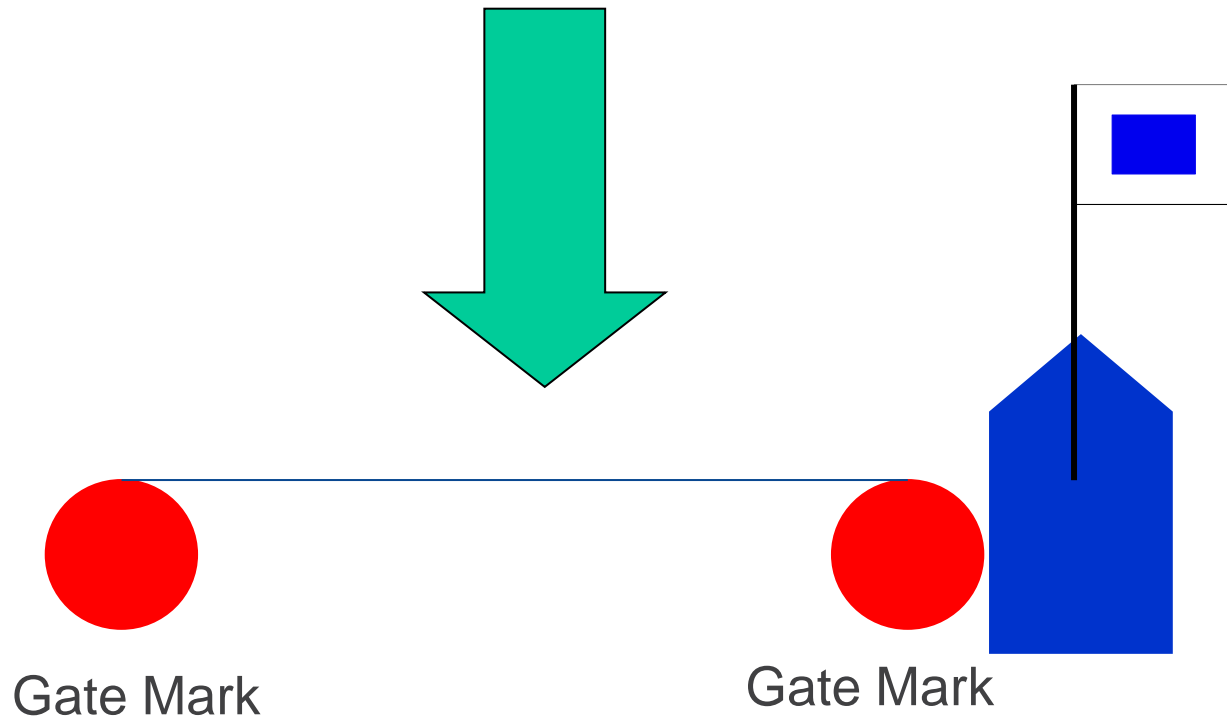

MARK MISSING

(RRS 34)

Flag 'M' with repetitive sound signal

- The object displaying this signal replaces a missing mark
- The object may be a boat or another buoy
- Before taking the above action, try to replace the mark or use a substitute of similar appearance

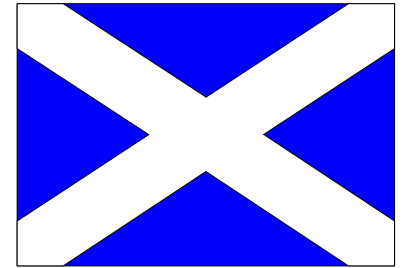

OTHER SIGNALS (1)

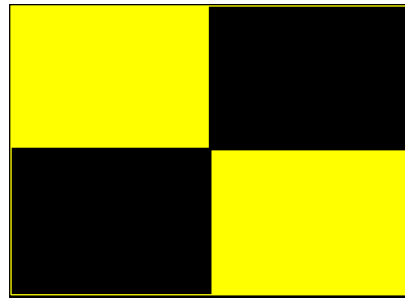

L Ashore: A notice to competitors has been posted

Afloat: Come within hail or follow this vessel

OTHER SIGNALS (1)

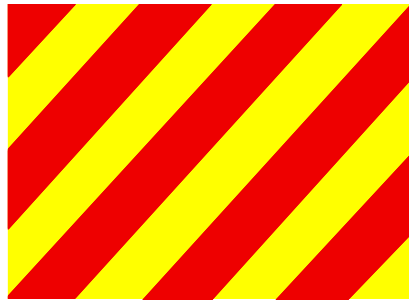

Y Wear personal buoyancy

FINISHING

Session 6

LAYING A FINISH LINE

On an upwind finishing line, the line must be set at:

- 90° to the wind direction

On all other legs of the course the finishing line must be set at:

- 90° to the last leg of the course

The finishing line should be 50 to 60 metres in length for most dinghy fleets or approximately 10 boat lengths.

LAYOUT OF FLAGS AT THE FINISH

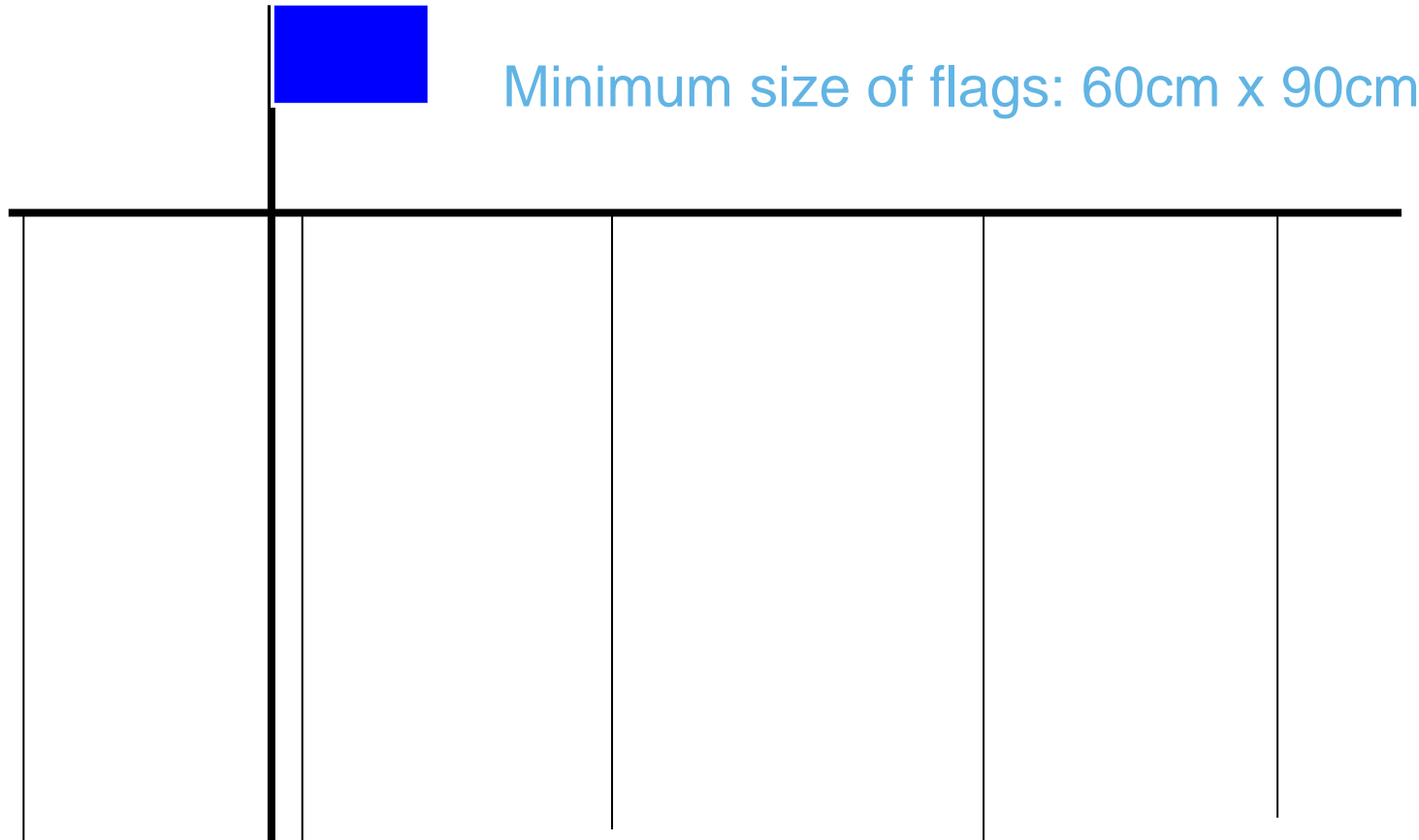

THE BLUE FLAG

- A staff displaying the Blue Flag is one end of the finishing line.
- It should be displayed, without a sound signal, when the leading boat commences the last leg to the Finish Line.

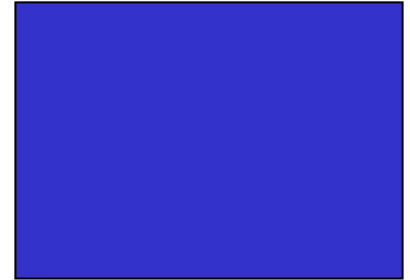

RECORDING

Recording the finish:

- Recording teams are a reader and a writer
- The reader calls the numbers out, recording them on a voice recorder
- The writer keeps a paper and pencil record
- Always have at least two recording teams
- For big fleets, have more

Remember:

- A start you can do over and over, the finish only once!

POST RACE TASKS

Session 7

POST RACE TASKS

- Account for all boats:
 - For Safety
 - For Scoring
- Results Service
- Protest Time
- Clean up and make sure everything is ready for next time
- Report and arrange for any damage to be repaired
- If requesting redress for competitors let someone ashore know
- Monitor sign on/off
- Follow up anything out of the ordinary that happens on the course – flares in the night

EVALUATION

- Always analyse your performance
- What could you do better?
- What went right, what went wrong and WHY?
- Talk to your team and other officials
- Most importantly, talk to the sailors

GPS

Session 8



GPS SET UP

- Map Datum: WGS 84
- Location Format: hddd°mm.mmm'
- North Reference: Magnetic
- Distance: Nautical Miles
- Time: 24 Hour
- Language: English

SETTING A COURSE USING A GPS

- Set the reference point and note number
- Press GOTO and select this point as your go to waypoint
- Proceed on the course angle provided by the RO and note your back angle and distance to the waypoint (i.e: course 160° = back bearing 340°)
- Once position is reached, check with RO and when confirmed, set mark
- Enter the mark's position as a waypoint
- Use the same principle to set all marks

PRACTICAL SESSION

Session 9

SETTING A COURSE USING A GPS

Split group into teams and simulate the following with both GPS and hand bearing compass:

- Laying a Start Line
- Laying the Windward Mark
- Laying the Gybe Mark
- Laying a Gate

Where to from here

How to become an Australian Sailing Club Race Officer

- Gain broad racing experience.
- Gather race rules knowledge.
- Proficiency in standard international Rules English.
- Support policies of Australian Sailing.
- Establish a rapport with your club and its community.
- Show a physical capability for delivering a day or two's competition on-water.

- To accredit or reaccredit you must have (Within last 4 years):
 - ✓ Completed the Club Race Officer seminar.
 - ✓ Supply a Club Letter of Endorsement via submit an accreditation application form (available on the as website).

There is no set order to achieving all of this.

Each of you will be at different levels of these skills and requirements

<https://www.sailingresources.org.au/officials-volunteers/nop-accreditation-forms/>



This concludes the seminar:

Enjoy the Journey.

Consider who you know that can help you – as a mentor.

Have fun and good luck!



The End
